

EXCLUDED FROM AUTOMATIC
DEGRADING DOD DIR 5700.10
DOES NOT APPLY

~~TOP SECRET~~

NATIONAL RECONNAISSANCE OFFICE
SATELLITE OPERATIONS CENTER

DESCRIPTION OF SIGINT MISSION 7334

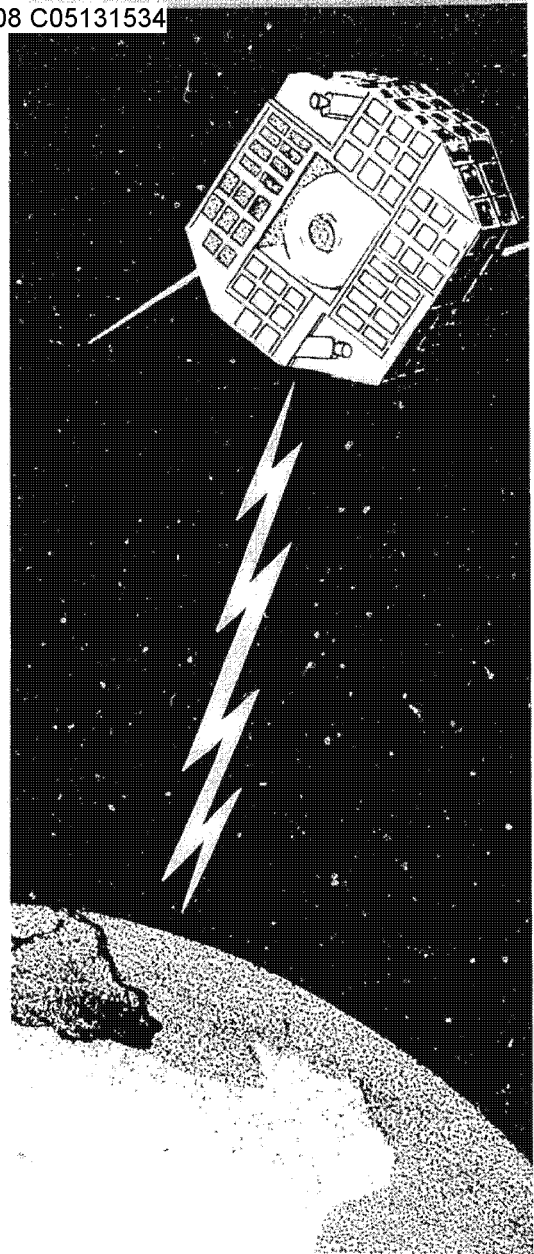

WARNING

This document contains information affecting the national security of the United States within the meaning of the espionage laws U. S. Code Title 18, Sections 793 and 794. The law prohibits its transmission or the revelation of its contents in any manner to an unauthorized person, as well as its use in any matter prejudicial to the safety or interest of the United States or for the benefit of any foreign government to the detriment of the United States. It is to be seen only by personnel especially indoctrinated and authorized to receive information in the designated control channels. Its security must be maintained in accordance with regulations pertaining to the designated controls.

prepared for sigint overhead reconnaissance subcommittee

handle via **TALENT-KEYHOLE** control only

GROUP 1
EXCLUDED FROM AUTOMATIC
DOWNGRADING AND DECLASSIFICATION

~~TOP SECRET~~

CONTROL NO. TCS-37595-70

COPY NO. _____ OF _____

~~TOP SECRET~~HANDLE VIA
TALENT-KEY
CONTROL SYSTEM

SIGINT Mission 7334 Mission Description

1. GENERAL INFORMATION

Mission 7334 is a reconnaissance receiver and data system that will perform general search for tropospheric-scatter communication signals in the 450-1000 MHz frequency range. The system will provide geopositioning data for the observed transmitting antennas within accuracy limits of 10 to 25 miles. In addition, the mission can provide data so that ground antenna pointing directions can be determined through postmission processing and analysis. The system will measure the target signal frequency and will record segments of the intercept signal information content when directed. A simplified block diagram of the system is shown in Figure 1.1.

This mission description discusses the following:

- a. Antenna Subsystem
- b. Receiver Subsystem
- c. Recognizer Subsystem
- d. Signal Measurement Subsystem
- e. Tape Recorders
- f. Mission Tasking Considerations
- g. Summary of System Characteristics

2. ANTENNA SUBSYSTEM

The antenna subsystem (shown in Figure 2.1) consists of four identical antennas configured into two arrays, one pointing south and the other north. Each array consists of two antennas mounted approximately 40 inches apart in a plane perpendicular to the spin axis; only one array at a time is selected for input. Each antenna is a conical spiral having approximately 3-db gain on axis,

HANDLE VIA
ENT-KEYHOLE
CONTROL SYSTEM~~TOP SECRET~~
EXCLUDED FROM AUTOMATIC DECLASSIFICATION
AND DOWNGRADING SCHEDULES, WHERE APPLICABLECONTROL NO. TCS-37595-7
COPY 1 OF 18 COPIES
PAGE 1 OF 18 PAGES

~~TOP SECRET~~

HANDLE VIA
TALENT-KEY
CONTROL SYSTEM

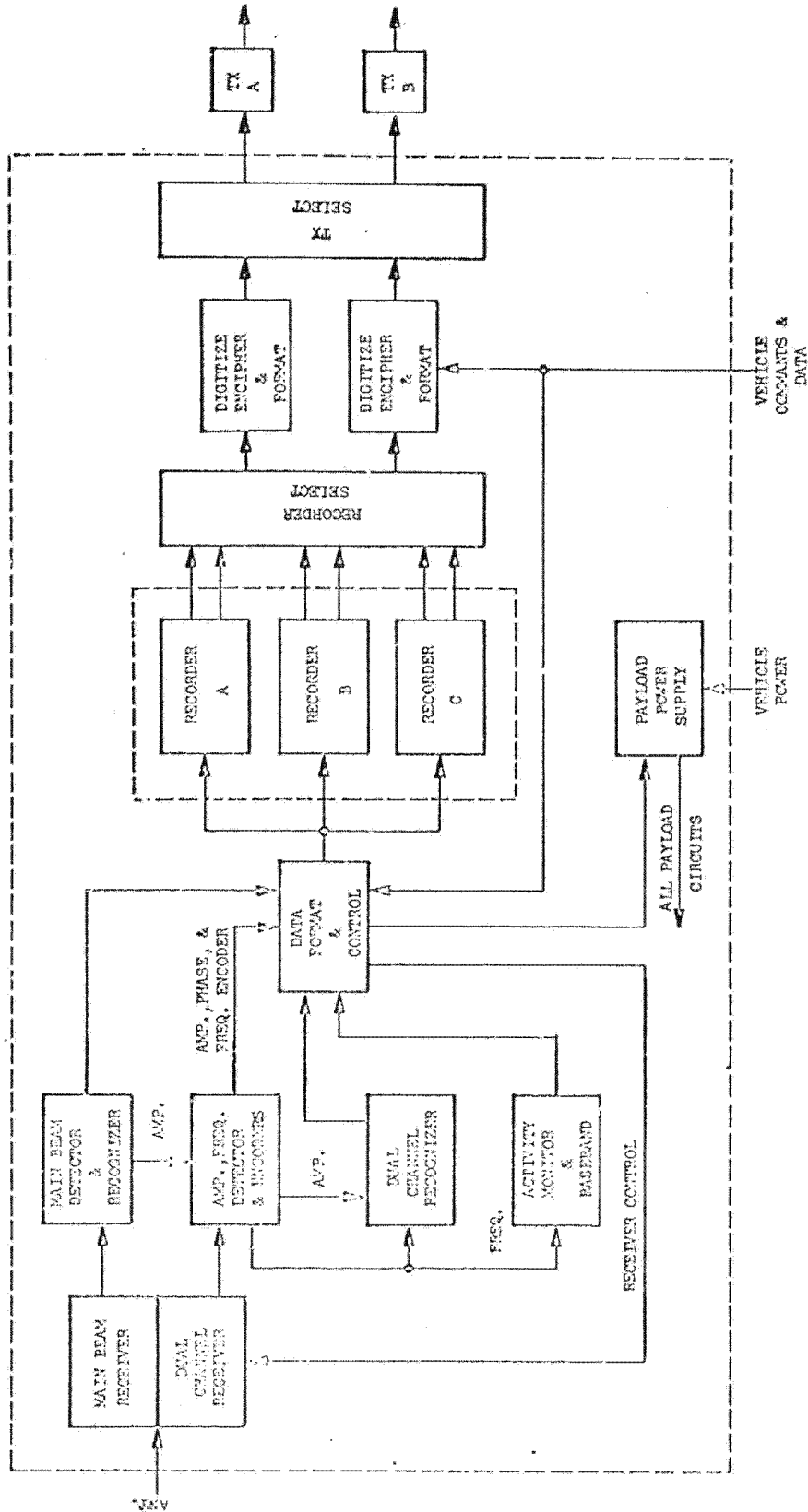

Figure 1 - Simplified Functional Block Diagram

HANDLE VIA
TALENT-KEYHOLE
CONTROL SYSTEM

~~TOP SECRET~~
EXCLUDED FROM AUTOMATIC DOWNGRADING
DOD DIRECTIVE 5200.10 DOES NOT APPLY

CONTROL NO. TCS-37595-
COPY _____ OF _____ COP
PAGE 2 OF 18 PAF

~~TOP SECRET~~

HANDLE AS
TALENT-KEYHOLE
CONTROL SYSTEM

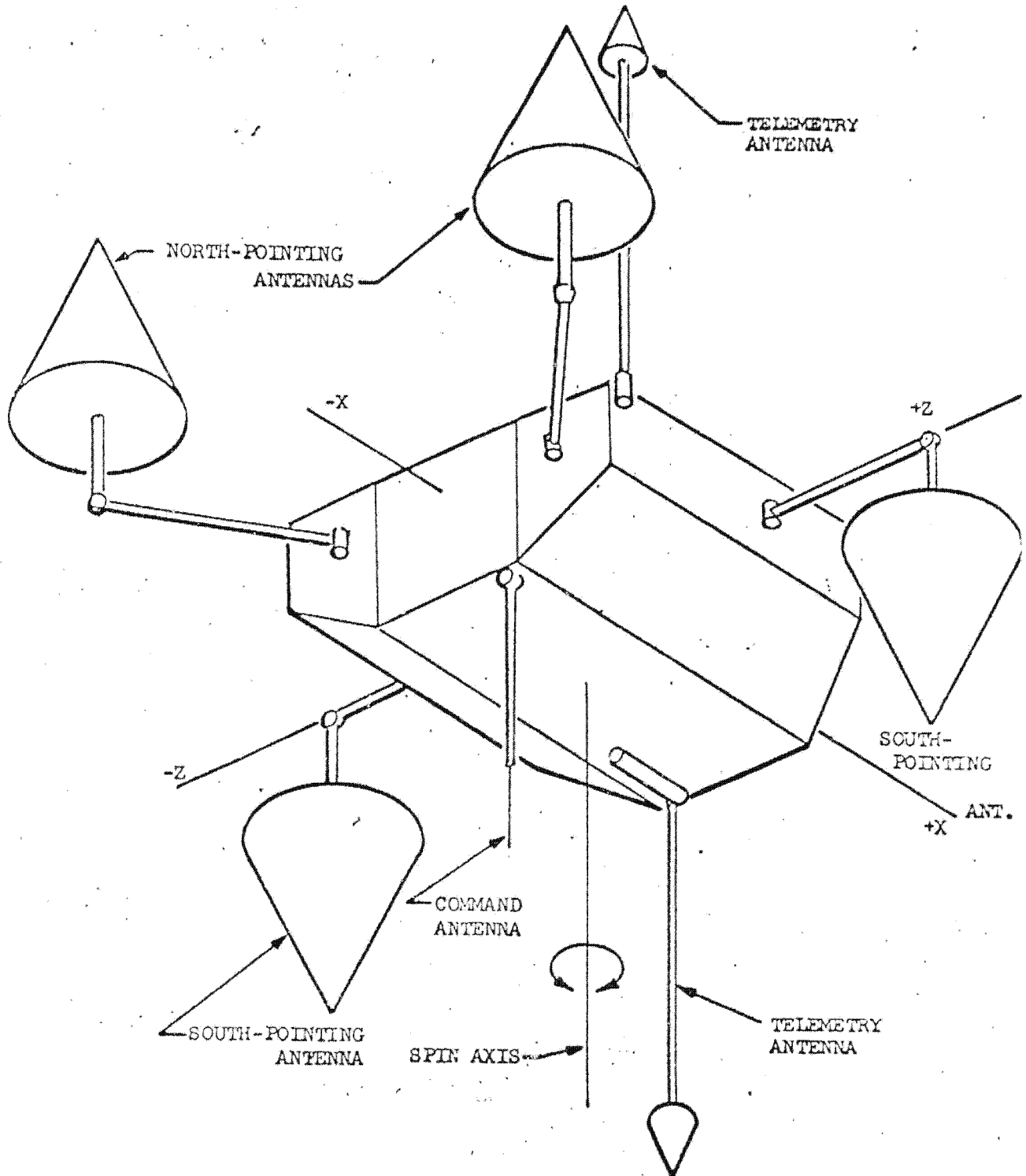

Figure 2-1 Antenna Subsystem

HANDLE AS
TALENT-KEYHOLE
CONTROL SYSTEM

~~TOP SECRET~~

EXCLUDED FROM AUTOMATIC DOWNGRADING
AND DECLASSIFICATION UNLESS OTHERWISE SPECIFIED

CONTROL NO. TCS-37595-71
COPY _____ OF _____
PAGE 3 OF 18

~~TOP SECRET~~HANDLE VIA
TALENT-KEYH
CONTROL SYSTEM

decreasing to approximately -8 db at 80 degrees off axis. The location of emitters, in terms of angle about spin axis and angle to spin axis, is determined by measuring the phase difference between antenna outputs as the vehicle spins.

3. RECEIVER SUBSYSTEM

The receiver subsystem consists of two receivers, a main-beam receiver (MBR) and a dual-channel receiver (DCR). The first receiver (MBR) detects and identifies the main antenna lobe from the target ground emitter. This receiver is primarily used to determine the ground emitter's pointing direction. The second receiver (DCR) is capable of detecting the sidelobes of the ground emitter and is used to determine the emitter's location, operating frequency, channel allocation and to provide signal copy. The requirement to simultaneously determine target location, as well as pointing direction, necessitates the use of two receivers in the subsystem. All received signals are processed into a format compatible with the tape recorder for recording; upon playback, the signals are reformatted and encoded for transmission to the ground.

3.1 Main-Beam Receiver.

The MBR is capable of tuning across the 450- to 1000-MHz band in 512 steps of approximately 1.09 MHz each. If no frequency segments are selected, the MBR will scan its entire frequency range. Also, its tuning range can be restricted to one, two, or three discrete frequency segments defined by the payload memory; if more than one frequency segment is selected, the MBR will scan the selected segments in rotation.

3.2 Dual-Channel Receiver.

The DCR is capable of tuning across the 450- to 1000-MHz frequency range in 1024 steps of 545 kHz each. These 1024 steps each define a unique scan starting and/or stopping frequency. If no frequency segments are selected, the DCR will scan the entire frequency range. However, it has the capability of being restricted to one, two, or three shorter frequency segments.

The DCR functions for any in-band signal in the range from -95 to -30 dbm. The DCR recognizer ignores signals below the receiver threshold, which is normally a noise-riding threshold. As a noise-riding threshold, the actual threshold can be set to any level between 7 and 28 db above noise in 3-db steps. In addition, the DCR threshold can be set to any level between -95 and -74 dbm in 3-db steps. The noise figure for the DCR is 8 db or less.

HANDLE VIA
TALENT-KEYHOLE
CONTROL SYSTEM~~TOP SECRET~~
EXCLUDED FROM AUTOMATIC DECLASSIFICATION
DOD DIRECTIVE 5200.10 DOES NOT APPLYCONTROL NO. TCS-37595-70
COPY _____ OF _____ COPIES
PAGE 4 OF 18 PAGES

~~TOP SECRET~~

HANDLE VIA
TALENT-KEYHOLE
CONTROL SYSTEM

3.3 Operating Modes.

Mission 7334 has three basic operating modes: search, recognize, and copy. The MBR and DCR can each operate independently in these modes or the DCR can be programmed to operate as a slave to the MBR in the recognize and copy modes.

3.3.1 Main-Beam Receiver Operating Modes.

- a. MBR Search Mode. In the search mode, the MBR steps across its tuning range, taking one step of approximately 1.09 MHz every 448 μ sec. During the first 224 μ sec, the MBR receives input from the south-looking antenna and determines whether any received signal (1) is above the commanded MBR threshold, (2) appears to and (3) is centered within the current frequency step. If any of these criteria are failed, the MBR repeats the test on the received signals from the north-looking antenna. If either antenna has been specified by command, the time assigned to the other antenna is spent waiting.

(b)(1)
(b)(3)

The MBR remains in the search mode until the above test is satisfied, at which time the MBR raises the SIGNAL PRESENT (SP) flag and transfers to the recognize mode.

- b. MBR Recognize Mode. In the recognize mode, the MBR tests the AM and FM characteristics of the received signal. The results of some of these tests (possibly all of them) are used to determine whether the received signal is acceptable for copying. In either case, the recognize mode terminates as soon as the result of the tests, plus a report on the signal level and identifications of the frequency step and antenna, are delivered to the output data formatter.

If the signal is rejected, the MBR reverts to the search mode. If the signal is accepted, the MBR transfers to the copy mode. Also, if the signal is accepted, the MBR issues a call-up to the DCR; but the DCR responds to this call-up only if it is slaved to the MBR.

- c. MBR Copy Mode. In the copy mode, the MBR repeats all the tests required in the recognize mode, except for the actual accept/reject test. It performs these tests, measures the input signal level, and reports the results once every 6.72 msec throughout the copy mode duration. The selected frequency steps and antenna are identified even though they don't change.

HANDLE VIA
VT-KEYHOLE
CONTROL SYSTEM

~~TOP SECRET~~
EXCLUDED FROM AUTOMATIC DECLASSIFICATION
DOD DIRECTIVE 5200.10 DOES NOT APPLY

TCS-37595-70
CONTROL NO. _____
COPY _____ OF _____ COPIES
PAGE 5 OF 18 PAGES

~~TOP SECRET~~HANDLE VIA
TALENT-KEY
CONTROL SYSTEM

The MBR copy mode continues for a time period as determined by command, with the last 20 msec of the copy mode being used to calibrate the MBR. At the end of the copy mode, the MBR reverts to the search mode, beginning with the south-looking antenna for input and the next higher frequency step.

3.3.2 DCR Operating Modes.

- a. DCR Search Mode. In the search mode, the DCR steps across its tuning range at the rate of one 545-kHz step every 560 μ sec. The DCR searches with one channel monitoring inputs from the north-looking antenna and the other monitoring inputs from the south-looking antenna. At each step, the DCR measures its own noise level and sets the proper threshold the commanded increment above this noise level. The DCR then determines whether it is receiving an apparent above this threshold; if so, it selects the antenna pair that will provide the strongest signal input and transfers to the recognizer mode. If no signal is present, it continues in the search mode.
- b. DCR Recognize Mode. In the recognize mode, the DCR first tests to determine whether the signal received is located within the current frequency step. If so, the SIGNAL PRESENT (SP) flag is raised and recognition continued. (If not, the DCR returns to the search mode.) At the same time, tests are initiated to determine the proper IF bandwidth for the signal and the AM and FM signal characteristics when the SP flag is up. The results of these tests determine whether the DCR should transfer to the copy mode.

(b)(1)
(b)(3)

If the signal is accepted, the DCR transfers to its copy mode immediately. If the signal is rejected but the SP flag is up, the recognize mode terminates only after the results of all recognizer tests have been delivered to the output data formatter.

- c. DCR Copy Mode. In the copy mode, the DCR measures and reports the differential phase between its two inputs once each 2.2 msec. The DCR also performs a spectral analysis of the intercepted signal baseband and measures the actual received signal frequency. The DCR continues to perform the TV and pilot tone tests, the results of which are sent to the output data formatter. These tests cannot cause an accepted contact to be rejected.

HANDLE VIA
ENT-KEYHOLE
CONTROL SYSTEM~~TOP SECRET~~
EXCLUDED FROM AUTOMATIC REGRADING
DDI DIRECTIVE 5200.10 DOES NOT APPLYCONTROL NO. TCS-37595-70
COPY _____ OF _____ COPIES
PAGE 6 OF 18 PAGES

~~TOP SECRET~~HANDLE VIA
TALENT-KEY
CONTROL SYSTEM

In addition to the above, the DCR actually copies a portion of the intercepted signal; that is, it copies the service channels and any one group of 12 information channels. (These channels are illustrated in Figures 4.1 and 4.2.) The DCR will continue to copy this information until the copy mode is terminated. The copy mode is terminated at the completion of the commanded dwell period, with the last 20 msec of the copy mode being used to calibrate the DCR.

An exception to the above is made when the DCR is slaved to the MBR, and the MBR calls up the DCR. In this case, the DCR terminates the copy mode (without a calibration period) the next time the DCR data are delivered to the output formatter.

In either case, the DCR returns to the search mode at the completion of the copy mode. Dwell periods are commandable in 1.5-, 3.0-, 10-, and 60-sec periods, but can continue as long as the signal is present and satisfactory if recognition is rechecked every 3, 10, or 60 sec.

3.3.3 Operating Procedures. The MBR and the DCR operate independently in the search for signals; when either acquires a potential signal-of-interest, that receiver evaluates the signal.

Acceptance of a signal by the DCR has no effect on the MBR. However, acceptance of a signal by the MBR results in a DCR call-up if the slave option has been selected. In the slave option, the DCR responds to a call-up by first storing a record of its current operating frequency and then transferring to the approximate operating frequency of the MBR. All this is done within 6.72 msec.

When called up, the DCR is switched to a low-gain and its threshold is set 3 db below the MBR threshold. The DCR then searches from 26 steps below (or bottom of band) to 26 steps above (or top of band) the step location indicated by the MBR. All signals detected are analyzed by the DCR recognizer, and the first acceptable signal is considered to be the correct signal.

If after one search of the possible area the DCR cannot locate an acceptable signal at the approximate location indicated by the MBR, it terminates the call-up and returns to search at the frequency stored in its register, with its original threshold and sensitivity levels. In this case, the MBR also abandons the signal, and no MBR calibration is provided.

After the DCR recognizer accepts a signal during a call-up, the MBR and DCR remain in the copy mode until the DCR terminates its copy mode. The DCR returns to normal sensitivity and threshold when the signal fails its elevated threshold.

HANDLE VIA
ENT-KEYHOLE
CONTROL SYSTEM~~TOP SECRET~~
EXCLUDED FROM AUTOMATIC REGRADING
DOD DIRECTIVE 5200.10 DOES NOT APPLYCONTROL NO. TCS-37595-70
COPY _____ OF _____ COPIES
PAGE 7 OF 18 PAGES

~~TOP SECRET~~HANDLE VIA
TALENT-KEYH
CONTROL SYSTEM

When the MBR is operating independently, termination of the copy period occurs when the signal drops below the MBR threshold. In the slave option, both the MBR and the DCR terminate the copy period when the signal drops below the DCR threshold. In either option, the copy period can be limited to 30 seconds by command.

4. RECOGNIZER SUBSYSTEM

Mission 7334 is required to recognize signals from an environment containing many interfering signals of relatively high field strength. Therefore, each receiver contains a recognizer that evaluates detected signals to determine whether they are of the desired type.

Table 4.1 lists the signal characteristics that each recognizer measures. The recognizer can be commanded to ignore any of these tests except the first two in determining which signals to accept. Once a signal is recognized as a target, signal frequency is measured, a spectral analysis of the FM base band is obtained, and samples of signal content are recorded.

4.1 Signal Environment.

The target emitters transmit 3- to 5-kilowatt, frequency-modulated, frequency-division-multiplex (FM/FDM) signals in 12-, 24-, 60-, or 120-channel formats. Figures 4.1 and 4.2 show these formats. Emitters operating between 450 and 700 MHz use 10-meter-diameter, open mesh dish antennas, and emitters operating between 700 and 1000 MHz use 60- by 60-foot and 100- by 100-foot antennas. Figure 4.3 shows the signal levels that will be received versus distance (on the ground) of the emitter from the nadir point.

Mission 7334 is required to select the above class of signals from a signal environment containing many interfering signals. Table 4.2 summarizes the characteristics of specific known interference sources. These sources will, in large part, be capable of generating field strengths equal to or greater than those produced by the target signal emitters.

4.2 Recognizer Tests.

The following specified tests (summarized in Table 4.1) are performed by the recognizer.

HANDLE VIA
ENT-KEYHOLE
CONTROL SYSTEM~~TOP SECRET~~EXCLUDED FROM AUTOMATIC DOWNGRADING
AND DOWNGRADING BY 5209 UNLESS OTHERWISE SPECIFIEDCONTROL NO. TCS-37595-7
COPY _____ OF _____ COPIES
PAGE 8 OF 18 PAGE.

~~TOP SECRET~~

HANDLE VIA
TALENT-KEYHOLE
CONTROL SYSTEM

Table 4.1

Available Recognition Criteria

Amplitude <input type="text"/>	Signal must exceed selected threshold level throughout a 60-usec period.
In-Band Confirm*	Signal center frequency must fall within selected step (center ± 375 kHz for DCR, ± 950 kHz for MBR).
Not TV	Must not contain typical TV horizontal retrace pulses. (AM)
FM Bandwidth (2 tests)	Must be FM at rates above 16 kHz. Must not be FM at rates above 552 kHz.
Pilot Tones (20-msec test) (2 tests)	Must be FM with an 8-kHz pilot tone Must be FM with a pilot tone at 248, at 250, or at 304 kHz.

(b)(1)
(b)(3)

*Signals not satisfying these tests are ignored.

HANDLE VIA
NT-KEYHOLE
CONTROL SYSTEM

~~TOP SECRET~~
EXCLUDED FROM AUTOMATIC DOWNGRADING
DOD DIRECTIVE 5200.10 DOES NOT APPLY

CONTROL NO. TCS-37595-70
COPY _____ OF _____ COPIES
PAGE 9 OF 18 PAGE

HANDLE VIA
LENT-KEYHOLE
 CONTROL SYSTEM

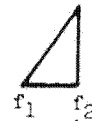

Single-Channel, 4-kHz wide. The audio signal occupies the 300- to 3400-Hz band within the channel.



12-Channel group, 48-kHz wide.



Pilot or control frequency.

- Notes: 1. Transmitted Power: 3 to 5 KW
 2. Signal Type: FDM/FM
 3. Antenna: 10-meter-Diameter dish

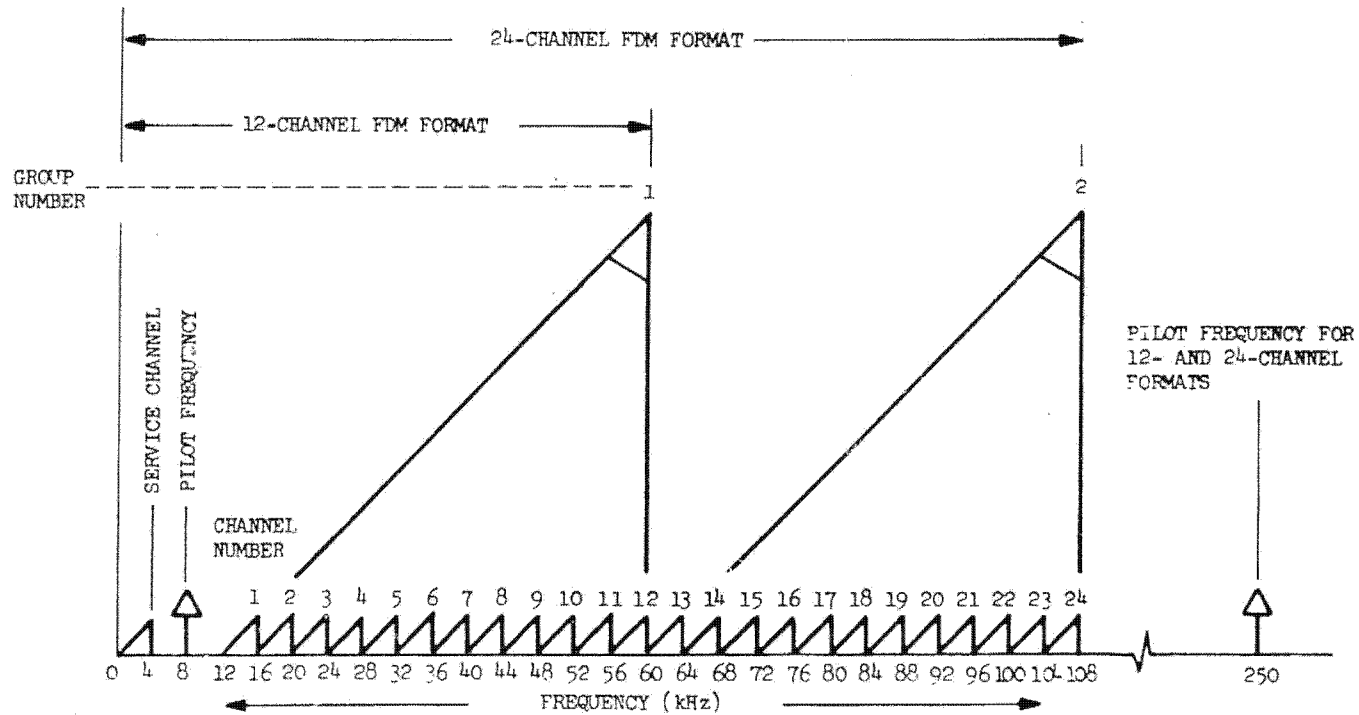

Figure 4.1 12- and 14-Channel FDM Format in the 450- to 700-MHz Band

TOP SECRET
 EXCLUDED FROM AUTOMATIC DOWNGRADING
 AND DECLASSIFICATION

CONTROL NO. TCS-37595-71
 COPY 10 OF 18 PAGES

TOP SECRET

HANDLE VIA
TALENT-KEY
 CONTROL SYSTEM

TALENT-KEYHOLE
 REF ID: A66543

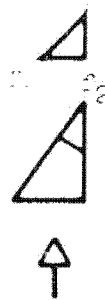

Single-Channel, 4-kHz wide. The audio signal occupies the 300- to 3400-Hz band within the channel.

12-Channel group, 48-kHz wide.

Pilot or control frequency.

- Notes:
1. Signal type: FDM/FM
 2. Transmitter Power: 3 to 5 kW
 3. Antenna: 60 x 60 ft or 100 x 100 ft billboard
 4. FM BW: 1.6 and 2.1 MHz

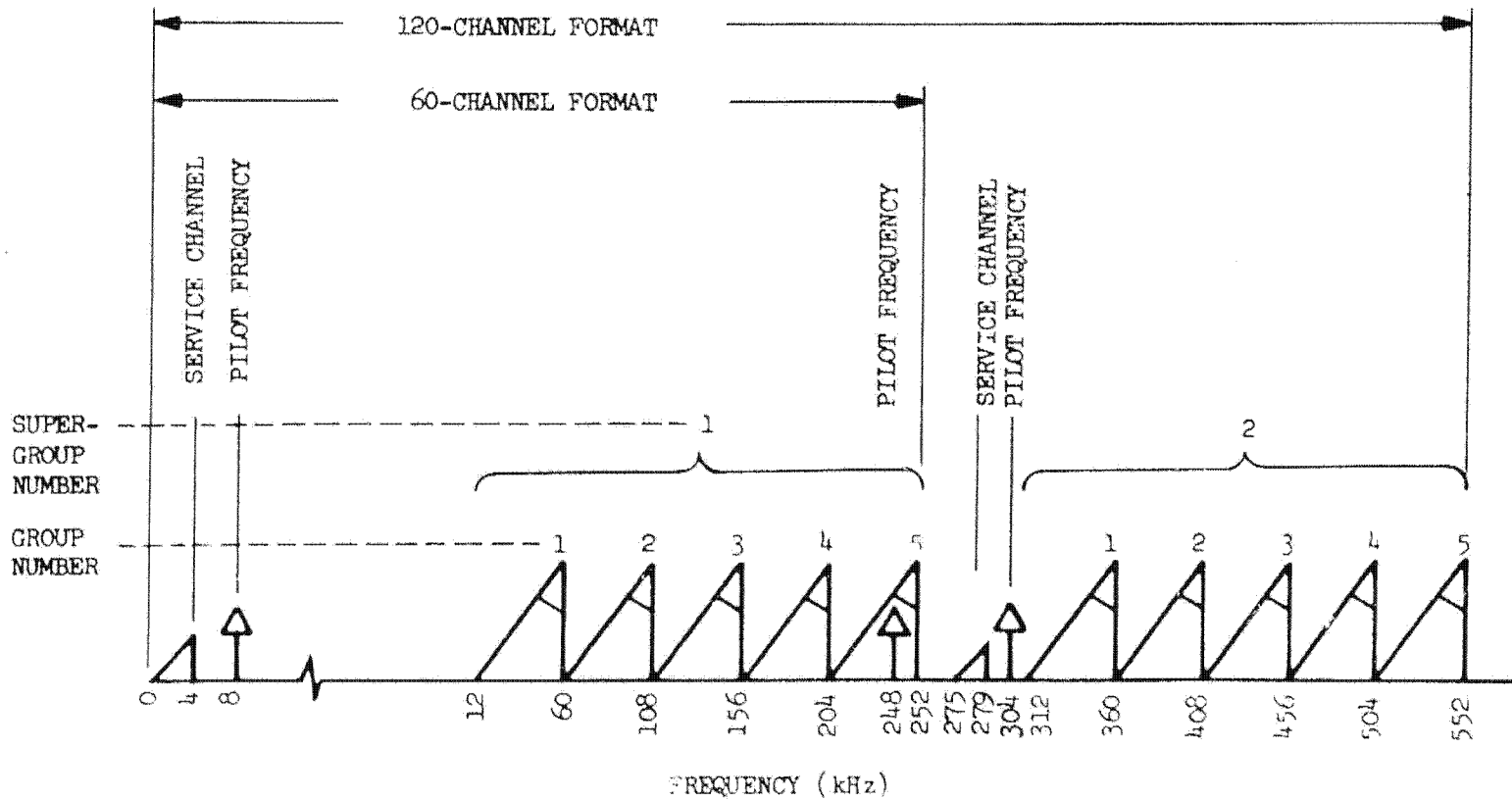

Figure 1-9 120-Channel FDM Format in the 700- to 1000-MHz Band

TOP SECRET
 EXCLUDED FROM AUTOMATIC DOWNGRADING AND DECLASSIFICATION
 UNLESS INDICATED OTHERWISE

TCS-37595-7
 FORM 11-5-18

TOP SECRET
 TALENT-KEYHOLE
 REF ID: A66543

HANDLE VIA
~~TALENT-KEYHOLE~~
CONTROL SYSTEM

~~TOP SECRET~~
EXCLUDED FROM AUTOMATIC DOWNGRADING
AND DOWNGRADING 5100.10 RULES NOT APPLY

CONTROL NO. TCS-37595-
COPY _____ OF _____
PAGE 12 OF 18 PAGES

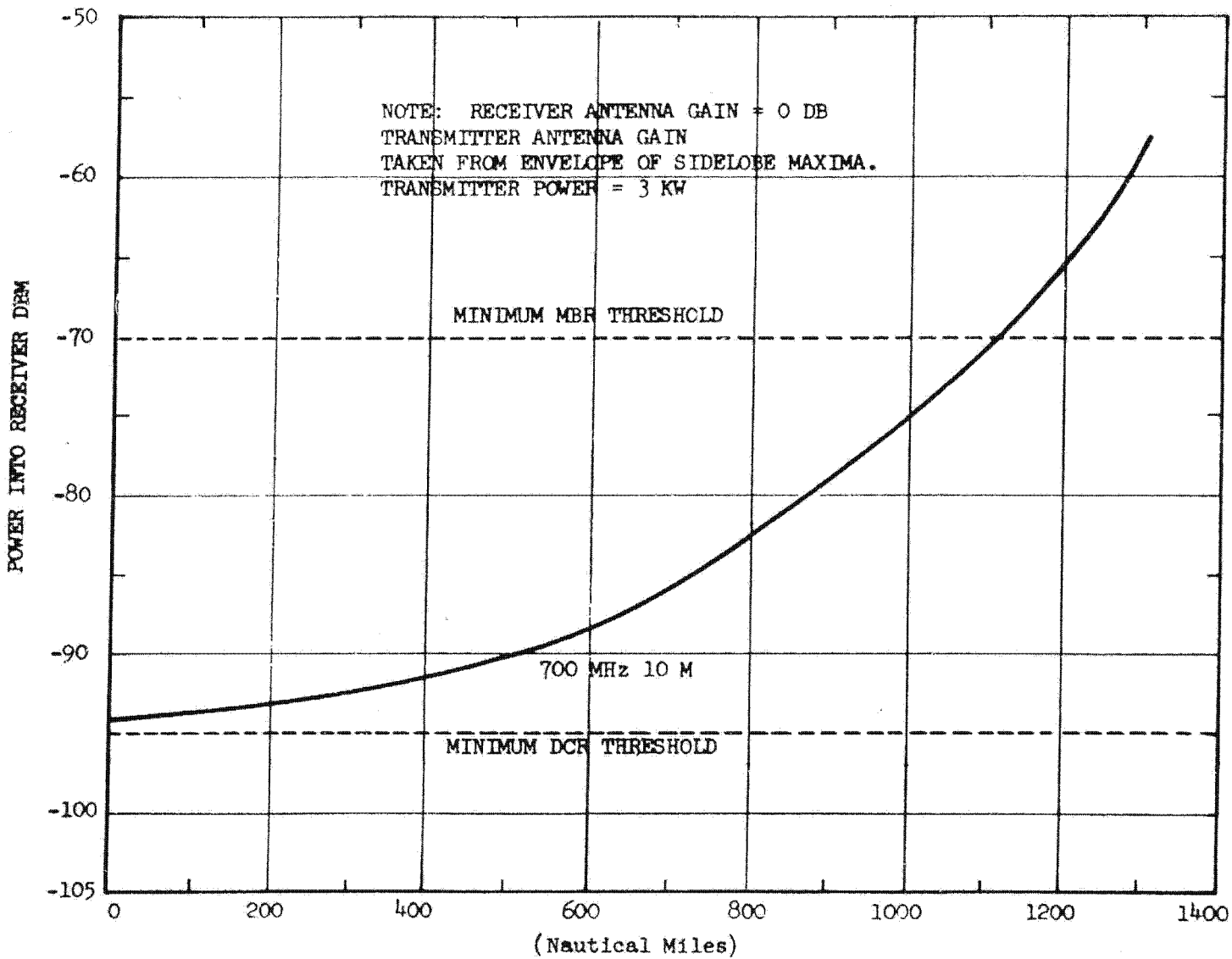

Figure 4.3 Input Power vs Distance From Nadir

~~TOP SECRET~~

HANDLE VIA
~~TALENT-KEY~~
CONTROL SYSTEM

~~TOP SECRET~~

HANDLE VIA
TALENT-KEYH
CONTROL SYSTEM

Table 4.2

INTERFERENCE SUMMARY

Signal Type	Modulation Type		Distinguishing Characteristics
	AM	FM	
Pulse Modulated telephone & telegraph	x	--	Audio frequencies modulating the amplitude, or position
Short-Pulse Radars	x	--	less than 60 usec
FM TV Video	--	x	Baseband above 552 kHz
FM TV Sound	--	x	No baseband above 15 kHz
AM TV Sound	x	--	Amplitude modulation only
AM TV Video	x	--	Line sync pulses

(b)(1)
(b)(3)

(b)(1)
(b)(3)

HANDLE VIA
ENT-KEYHOLE
CONTROL SYSTEM

~~TOP SECRET~~
EXCLUDED FROM AUTOMATIC DEGRADING
DDG DIRECTIVE 5200.10 DOES NOT APPLY

CONTROL NO. TCS-37595-70
COPY _____ OF _____ COPIES
PAGE 13 OF 18 PAGES

~~TOP SECRET~~HANDLE VIA
TALENT-KEYHOLE
CONTROL SYSTEM

TV Test. This test determines whether the characteristic horizontal retrace pulses of a TV video signal are present. If such pulses are present, the signal has failed the TV test.

FM Bandwidth Test. This test determines the spectral distribution of the FM baseband energy and categorizes signals as narrowband, normal-band, and wideband signals. Non-FM and TV audio signals are considered to be narrowband signals, and TV video signals are considered to be wideband signals. The recognizer can be commanded to reject either or both narrowband and wideband signals. This test is replaced by the spectrum analysis test in the DCR during the copy phase.

Pilot Tone Test. This test determines whether the FM band contains certain tones. A broadband white noise spectrum does not satisfy this test. This test may be configured to require a tone at 8 kHz. It may, independently, require an additional tone at one of the following three frequencies: 248, 250, or 304 kHz. The presence of any one of these frequencies will satisfy this part of the test.

Accept/Reject Test. The recognizer is configured to consider only those tests that have been selected by command. It accepts any signal presented to it that satisfied all the selected tests. In addition, if both the FM bandwidth and the pilot tone tests are selected, the recognizer can be commanded to accept a signal that fails either one, but not both, of these tests.

DCR Bandwidth Test. The DCR recognizer also performs an added bandwidth test on the received signal. When commanded to its adaptive bandwidth mode, the DCR selects the proper DCR IF bandwidth according to the outcome of this test. This test is not a part of the accept/reject decisions made for the other tests and is not performed in the DCR copy mode.

4.3 MBR Recognizer.

The MBR recognizer performs each test once during a recognition mode period. The TV test can be satisfied in as little as $100\mu\text{sec}$, whereas the FM bandwidth test requires $528\mu\text{sec}$ to perform. If pilot tones are required, and all other requirements are satisfied, recognition continues until tones are detected or until 20 msec have passed. The MBR recognition mode terminates when the signal is accepted or rejected.

4.4 DCR Recognizer.

The DCR recognizer performs each test once during a recognition phase. In-band confirm and the amplitude and duration tests are checked after $1104\mu\text{sec}$

HANDLE VIA
ENT-KEYHOLE
CONTROL SYSTEM~~TOP SECRET~~
EXCLUDED FROM AUTOMATIC REGRADING
DDI DIRECTIVE 5200.10 DOES NOT APPLYCONTROL NO. TCS-37595-70
COPY _____ OF _____ COPIES
PAGE 14 OF 18 PAGES

~~TOP SECRET~~HANDLE VIA
TALENT-KEYHOLE
CONTROL SYSTEM

to determine if the SIGNAL PRESENT marker is justified. When pilot tones are required and all other requirements are satisfied, recognition continues until the tones are detected or 20 msec have passed. This assures detection of any pilot tones present. The DCR recognition mode terminates when the signal is accepted or rejected.

5. SIGNAL-MEASUREMENT SUBSYSTEM

So that received signals can be analyzed, certain signal measurements are made by each receiver.

5.1 MBR Signal Measurements.

The following are measured by the MBR:

- a. Signal Amplitude. The amplitude of all signals received is measured and reported on the average of once each 6.72 msec. Resolution is 1.0 db nominal. This is the measurement used to derive ground antenna pointing directions.
- b. Step Frequency. Center frequency is reported each time signal amplitude is reported. Frequency is accurate within ± 5 MHz after temperature compensation.
- c. Recognizer. Results of recognizer tests are reported each time signal amplitude is reported.

5.2 DCR Signal Measurements.

The following are measured by the DCR:

- a. Threshold. The threshold level is measured once every 6.72 msec at time intervals compatible with the output data formatter requirements. Threshold level is reported with a resolution of 1 db or better.
- b. Signal Amplitude. The amplitude of all signals received is measured once every 6.72 msec, with a resolution of 0.8 db, and reported to output data formatter.

HANDLE VIA
ENT-KEYHOLE
CONTROL SYSTEM~~TOP SECRET~~
EXCLUDED FROM AUTOMATIC DECLASSIFICATION
DOD DIRECTIVE 5200.10 DOES NOT APPLYCONTROL NO. TCS-37595-70
COPY 15 OF 18 COPIES
PAGE 15 OF 18 PAGES

~~TOP SECRET~~HANDLE VIA
TALENT-KEY
CONTROL SYSTEM

- c. Step Frequency. Center frequency is reported each time signal amplitude is reported. Stability is such that no step drifts more than 20 kHz during a 15-min readin period in a fixed external environment.
- d. Fine Frequency. The average received signal is measured and reported with an accuracy of ± 100 kHz for signals within the control half of the reportable range, i.e., signals within one-half step of the DCR center frequency. Measurement is performed once per subframe cycle as long as the DCR is in the copy mode. Resolution is 8.516 kHz (128 levels for ± 545 kHz).
- e. Recognizer. Results of recognizer tests are reported each time signal amplitude is reported.
- f. Spectral Analysis. While in the copy mode, the FM baseband of the received signal is subjected to a spectral analysis that consists of measuring the activity of a 12-channel group. Each of 10 such groups is evaluated and results reported during each subframe cycle.
- g. Phase. The phase difference between the two DCR channels is measured and reported once every 2.24 msec while in the copy mode. This is the measurement used to determine transmitting antenna locations.

6. TAPE RECORDERS

Mission 7334 is equipped with three magnetic tape recorders for storage of payload data; one of the tape recorders is for backup. Each tape recorder has two tracks capable of recording data up to 150 kHz in frequency for a maximum of 375 seconds, with a readin readout ratio of 1:1. It is possible to command either one or two readin periods. Serial tape recorder readins for a total of approximately 750 seconds duration with no loss of payload data during recorder transfer is a design feature. It should be noted that only one tape recorder may be selected per readin period. It should also be noted that the mission cannot be operated in a transpond mode (i.e., data must be recorded and dumped).

7. TASKING CONSIDERATIONS

Although the MBR and DCR have the capability of being restricted to one, two, or three frequency segments, the combined operating configuration is only capable of accepting a total of three frequency segments. That is, it is not possible to establish three frequency segments for the MBR and then to establish

HANDLE VIA
TALENT-KEYHOLE
CONTROL SYSTEM~~TOP SECRET~~
EXCLUDED FROM AUTOMATIC DOWNGRADING
DOWNGRADING DIRECTIVE 5200.10 DOES NOT APPLYCONTROL NO. TCS-37595-71
COPY _____ OF _____ COPIES
PAGE 16 OF 18 PAGE

~~TOP SECRET~~

HANDLE VIA
TALENT-KEYHOLE
CONTROL SYSTEM

three new and separate frequency segments for the DCR. A total of three frequency segments may be established and the MBR and the DCR may be independently programmed to search any none, one, two, or all three. A consideration should be made of the fact that if the DCR is assigned to search a segment that is not made available to the MBR, then no emitter pointing directions will be determined for that segment.

It should be noted that in the copy mode, the intercept signal information content is limited to one specified group of 12 channels plus the service channels. The particular group of 12 channels must be specified in advance of signal detection.

A possible trade-off exists between numbers of different emitters intercepted and amount of copy time per signal by adjusting the dwell period in the DCR copy mode or making the DCR dwell periods indefinite.

8. SUMMARY OF SYSTEM CHARACTERISTICS

A summary of pertinent system characteristics is contained in Table 8.1.

HANDLE VIA
NT-KEYHOLE
CONTROL SYSTEM

~~TOP SECRET~~
EXCLUDED FROM AUTOMATIC REGRADING
DOD DIRECTIVE 5200.10 DOES NOT APPLY

CONTROL NO. TCS-37595-70
COPY _____ OF _____ COPIES
PAGE 17 OF 18 PAGES

~~TOP SECRET~~

HANDLING
TALENT-KEYHOLE
 CONTROL SYSTEM

Table 8.1

SUMMARY OF SYSTEM CHARACTERISTICS

	Dual-Channel Receiver	Main-Beam Receiver
Frequency Coverage	450-1000 MHz	450-1000 MHz
Number of Steps	1024	512
Step Spacing	545 kHz	1.09 MHz
Step Size	750 kHz	1.30 MHz
Noise Figure	8 db	27 db
Dynamic Range		
High-Gain Configuration	-95 to -55 dbm	
Low-Gain Configuration	-70 to -30 dbm	-70 to -30 dbm
Threshold Level		
(8 Command Options)	-95 to -74 dbm	-70 to -49 dbm
Spurious Rejection	55 db	55 db
Accuracy:		
Emitter Location	10-25 n.m.	
Signal Frequency	± 100 kHz	± 5 MHz
Signal Amplitude	0.8 db	1.0 db
Band Scan Time		
No Contacts	573.44 msec	229.876 msec
False Alarm Every Step*		
TV, FM Station	6.881 sec	3.441 sec
Worst Case	20.644 sec	10.322 sec

*Scan speed limited by data channel capacity.

HANDLING
ENT-KEYHOLE
 CONTROL SYSTEM

~~TOP SECRET~~
 EXCLUDED FROM AUTOMATIC DECLASSIFICATION
 DOD DIRECTIVE 5200.10 DOES NOT APPLY

CONTROL NO. TCS-37595-70
 COPY _____ OF _____ COPIES
 PAGE 18 OF 18 PAGES