

Draw

with

NRO

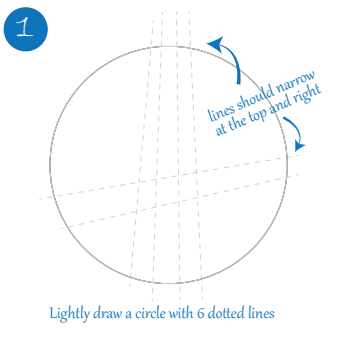
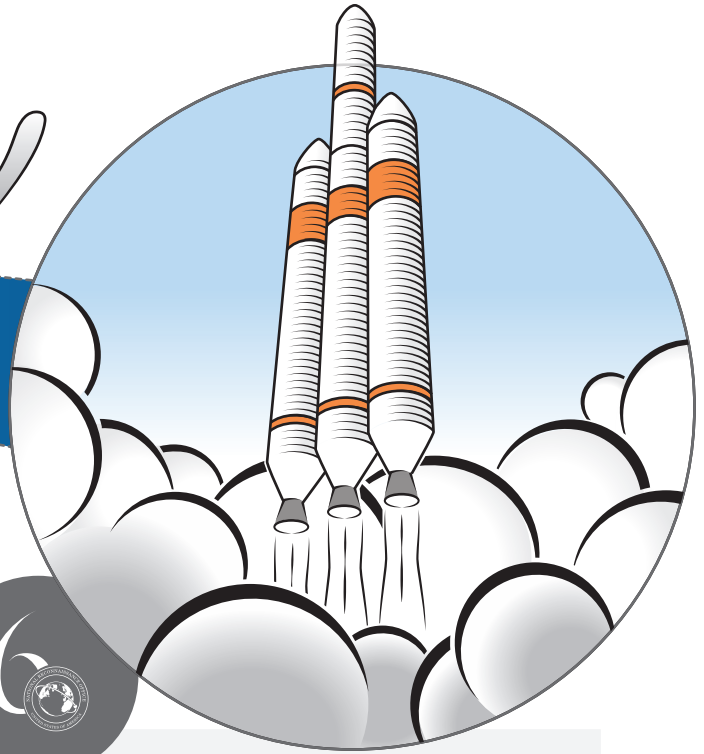

Lightly draw a circle with 6 dotted lines

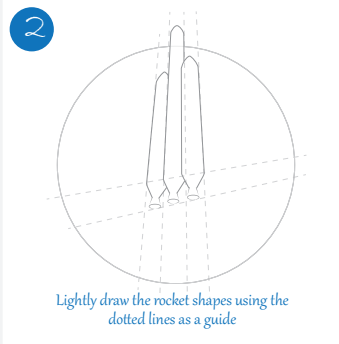

Lightly draw the rocket shapes using the dotted lines as a guide

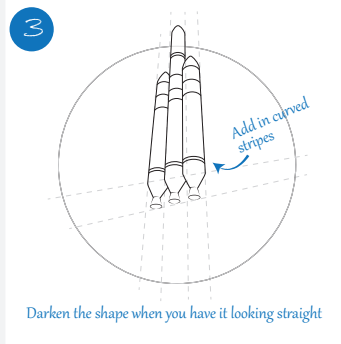

Darken the shape when you have it looking straight

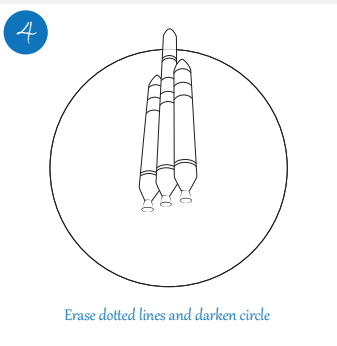

Erase dotted lines and darken circle

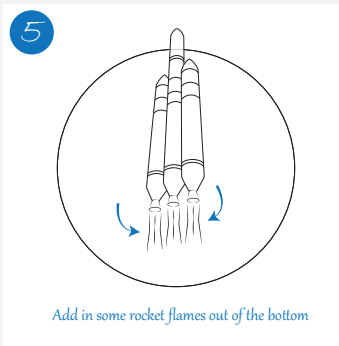

Add in some rocket flames out of the bottom

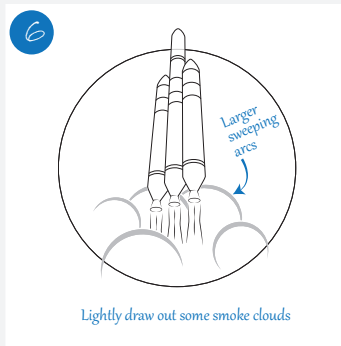

Lightly draw out some smoke clouds

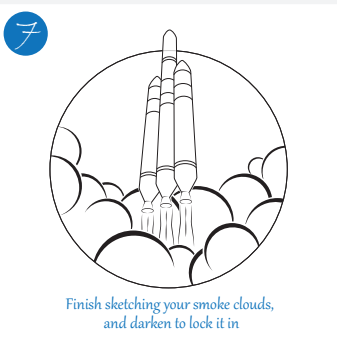

Finish sketching your smoke clouds, and darken to lock it in

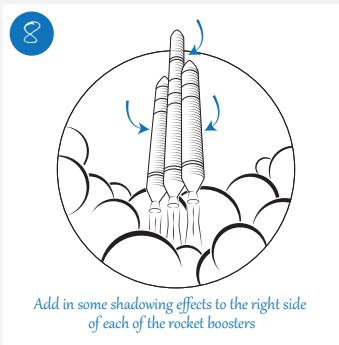

Add in some shading effects to the right side of each of the rocket boosters



Add in some color and cloud shadows