

~~CONFIDENTIAL~~

BASELINE RENDEZVOUS CONFIGURATION GENERAL ARRANGEMENT

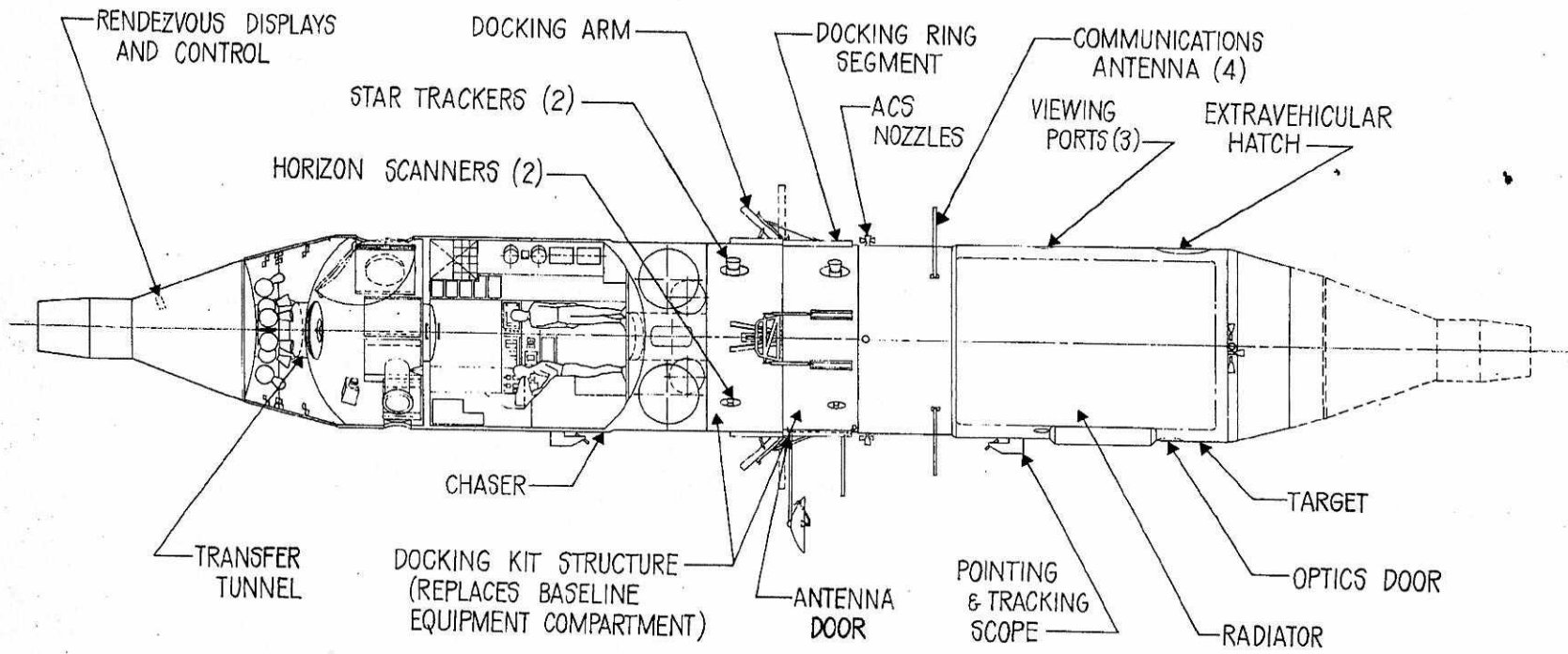

ALL INFORMATION CONTAINED HEREIN IS UNCLASSIFIED EXCEPT WHERE SHOWN OTHERWISE. DATE 08-11-2010 BY 60322 UCBAW/STP/STP

~~CONFIDENTIAL~~

DOWNGRADED AT 3 YEAR INTERVALS
RECLASSIFIED AFTER 13 YEARS
DOD OIR 5300.10

apr 23 1988

2

WOL-4 -Y18836-R-
AD64 0000 03794 003

~~SECRET~~

VEHICLE CONFIGURATION

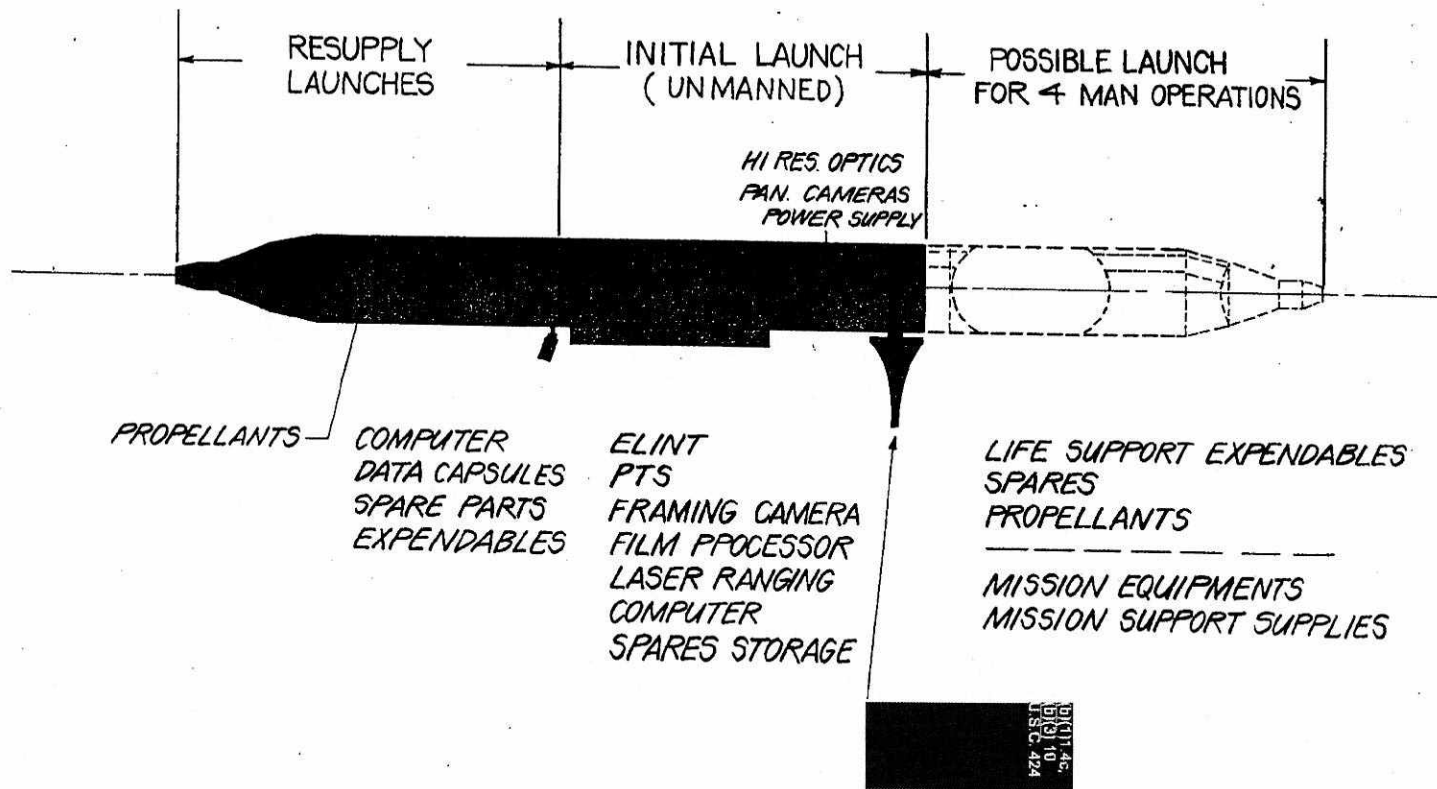

~~SECRET~~

THIS DOCUMENT CONTAINS INFORMATION AFFECTING THE NATIONAL DEFENSE OF THE UNITED STATES WITHIN THE MEANING OF THE ESPIONAGE LAWS, TITLE 18 U.S.C. SECTION 793 AND 794, ITS TRANSMISSION OR THE REVELATION OF ITS CONTENTS IN ANY MANNER TO AN UNAUTHORIZED PERSON IS PROHIBITED BY LAW.

DOWNGRADED AT 12 YEAR INTERVALS, NOT AUTOMATICALLY DECLASSIFIED, DOD DIR 520010

AEROSPACE CORPORATION

IN 11-19 64

~~CONFIDENTIAL~~

LABORATORY VEHICLE INTERIOR ARRANGEMENT

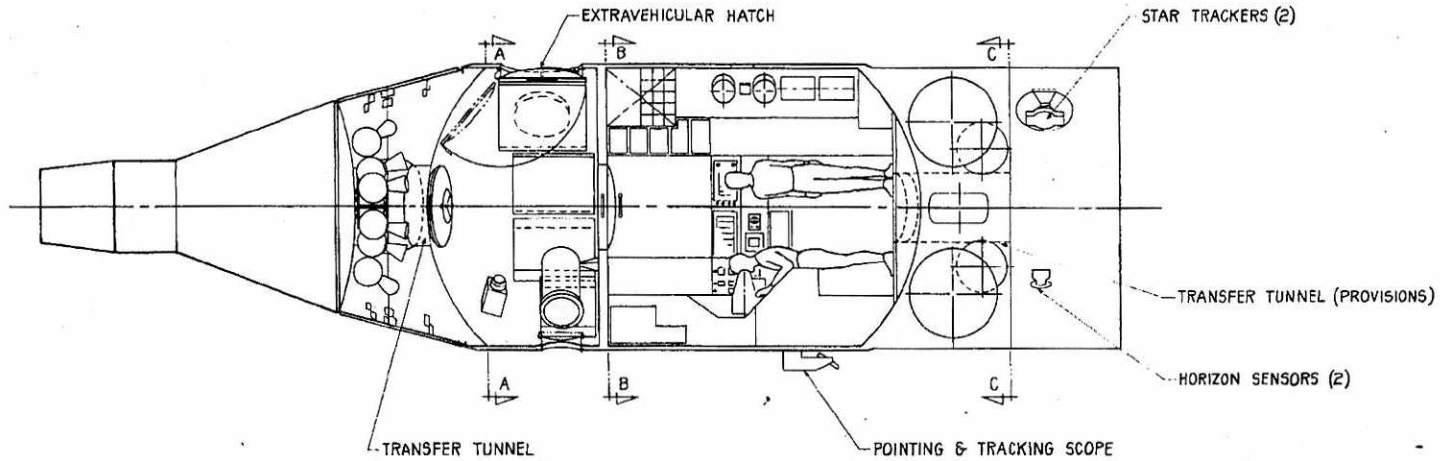
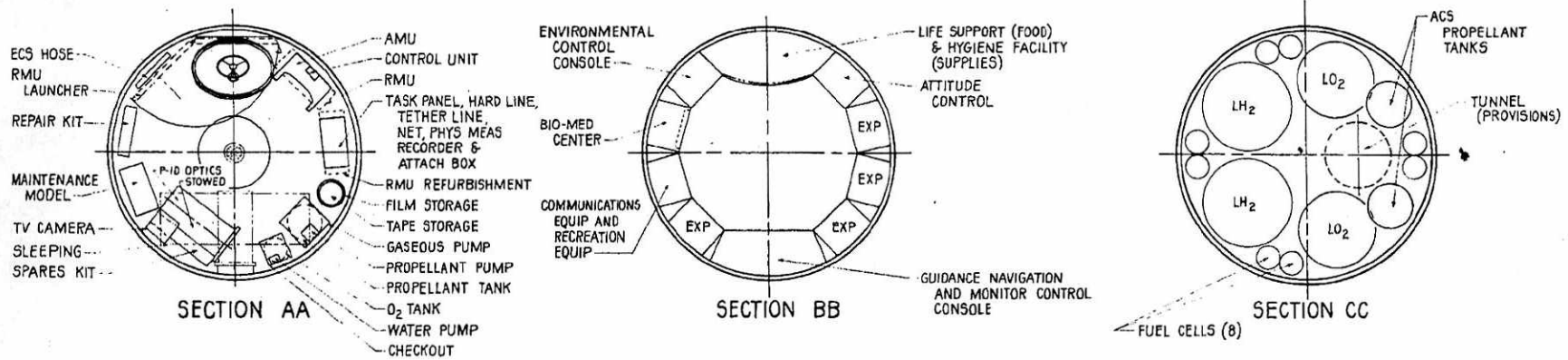

THIS DOCUMENT CONTAINS INFORMATION AFFECTING THE NATIONAL DEFENSE OF THE UNITED STATES WITHIN THE MEANING OF THE INTELLIGENCE LAWS, TITLE 18 U.S.C. SECTION 793 AND 794, AND THE TRANSMISSION OR THE REVELATION OF ITS CONTENTS IN ANY MANNER TO AN UNAUTHORIZED PERSON IS PROHIBITED BY LAW.

~~CONFIDENTIAL~~

DECLASSIFIED AT 3 YEAR INTERVALS,
DECLASSIFIED PERIOD: 12 YEARS
DDI DIR 5-100-10

AEROSPACE CORPORATION



21

V19815

MODULAR CONCEPT

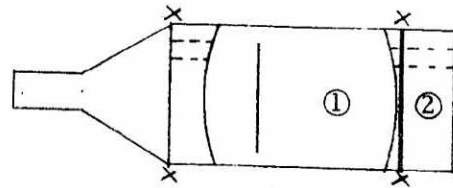

● INITIAL MOL FLIGHTS

- ① : CAN; INCL. MISSION EQUIPT.
- ①A : CAN; LESS MISSION EQUIPT.
- ② : FUEL CELL/PROPELLANTS/
TEST MODULE SECTION
- ③ : SENSOR MODULE

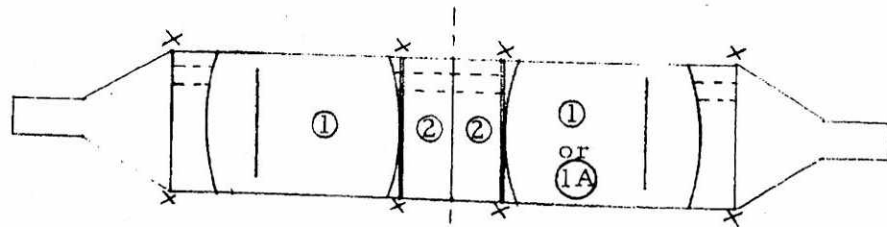

● BACK-TO-BACK RENDEZVOUS

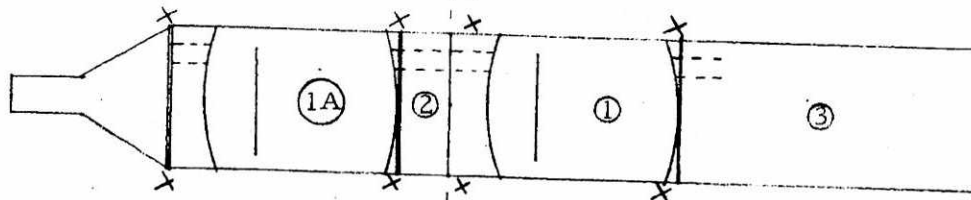

● OPERATIONAL FLIGHTS

RESUPPLY 1ST LAUNCH (UM)

VI9809
AD65-0000-00259-003

OPERATIONAL CONFIGURATION CONCEPT

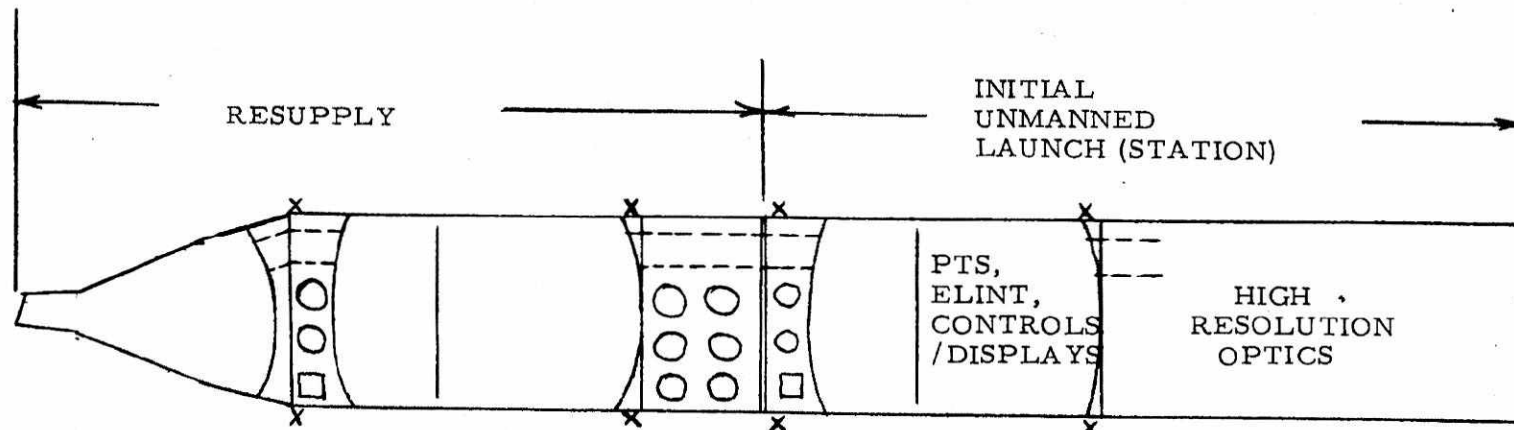

- ATTITUDE CONTROL/SUSTENANCE
- POWER (FUEL CELLS)
- LIFE SUPPORT (ECS + EXPENDABLES)
- MISSION SUPPLIES (E. G. FILM)
- DATA CAPSULES
- REACTANTS & PROPELLANTS

← OR →

- ATTITUDE CONTROL/SUSTENANCE (RADIOISOTOPES)
- LIFE SUPPORT (ECS)
- SENSORS
- INFORMATION SUBSYSTEM
- CONTROL/DISPLAYS

(Faint, illegible text, likely bleed-through from the reverse side of the page)

~~SECRET~~
DOWN GRAD AT 12 YEAR
INTERVALS; NOT AUTOMATICALLY
DECLASSIFIED. DOD DIR 5206.10